

 **Matsura**

5-Axis Multi-Tasking Machining Center

CUBLEX-63



MAXIA
Innovation by  Matsura

Matsuura CUBLEX-63

A New Era in Unmanned Multi-Tasking Machines has Arrived. Milling & Turning: “One Hit” Multi Pallet, 5-Axis CNC Processing

The **CUBLEX-63** 5-Axis Multi-Tasking machine tool ushers in a new era of high performance CNC production processing, expanding the manufacturing horizons & possibilities of CNC users worldwide.

Process Integration

CUBLEX-63 Main Features

- Developed from the market proven design of the Matsuura **MAM72-63V**, the **CUBLEX-63** offers users outstanding 5-Axis Milling capabilities coupled with an integrated high end Turning Center.
- Highly rigid & stable Milling & Turning.
- Spacious machining area with minimal interference.
- Eliminates accumulated errors & vastly reduces set-up times by removing the need for separate Milling & Turning machines.
- Robust & proven $1,300 \text{ min}^{-1}$ chuck rotational speed in turning mode.
- One Hit processing, large multi pallet changers & Milling & Turning in the same machine tool assures extended periods of reliable unmanned operation.
- Small Machine Footprint.

One-Hit
Multi-Tasking

Precise
Milling



Machining

Multi-
Tasking

Turning

Grinding
Option



Extended Work Size

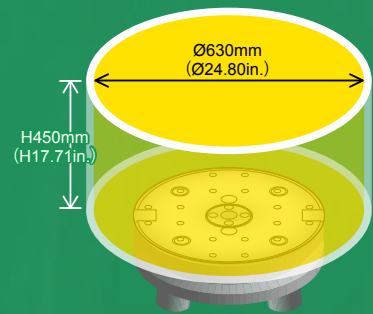

※Grinding functionality is an Option - see Page 15 for details

MAXIA
Innovation by  Matsura

The Future of 5 Axis Multi Tasking Functionality The Matsuura **CUBLEX-63** has Arrived

The Matsuura **CUBLEX-63** - Three machines in One

Integrated Machining & Turning functionality offers a vast reduction in set up & production times & removes accumulated errors between operations.

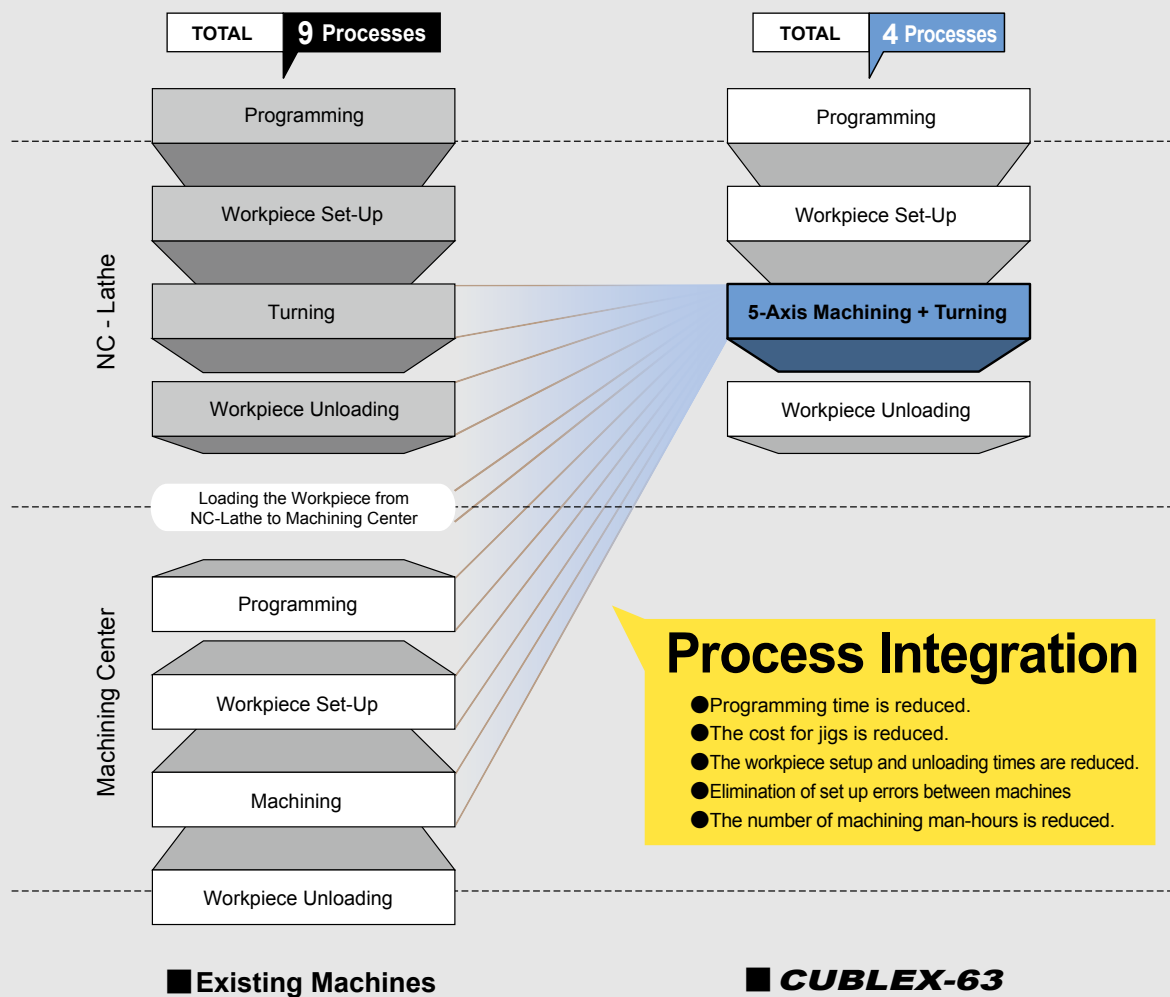

New Production Possibilities - The **CUBLEX Series** of True Multi Tasking Machines

Effortless G-code functionality changes modes quick and simply.

Vertical Turning \longleftrightarrow Horizontal Turning \longleftrightarrow 5-Axis Machining \longleftrightarrow Grinding Option

The modes are freely changed, and the lead time & errors between processes are reduced.

※Grinding functionality is an Option - see Page 15 for details

Vertical Turning



5-Axis Machining



Horizontal Turning



Grinding

Option

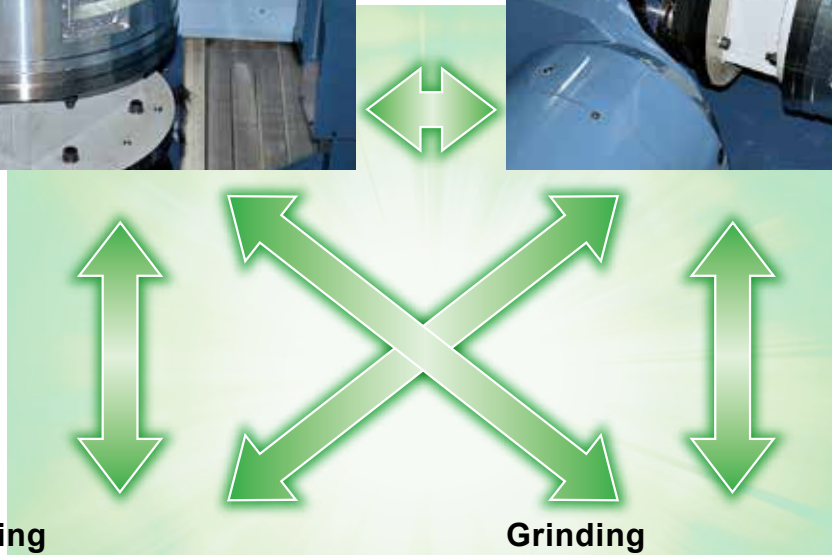

Unmanned Operation on the **CUBLEX-63** Achieves Reduced Setup & Cycle Times & a Faster Return on Investment

Lineup of a Wide Array of Options

The **CUBLEX-63** comes equipped with a twin pallet changer **PC2** & 51 tools as standard. Optional large capacity Multi Pallet Systems & Matrix Magazines dramatically increase cost effective unmanned operation & lights out production.

Multi Pallet Systems

Option

- APC option line-up for continuous unmanned production.

PC6

Floor Pallet system
Compact, fully integrated & expandable multi pallet system

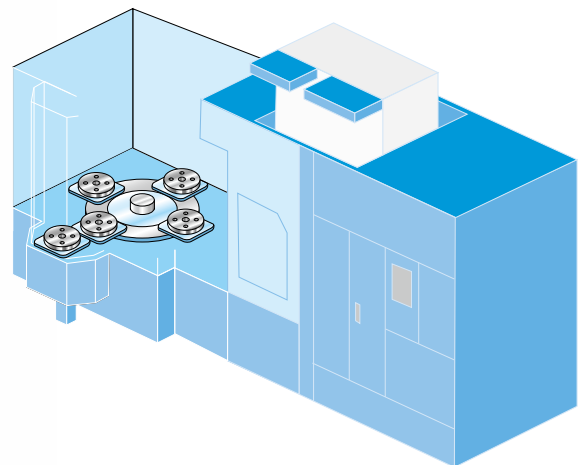

PC18

Tower Pallet system
Vertically aligned space saving multi pallet system

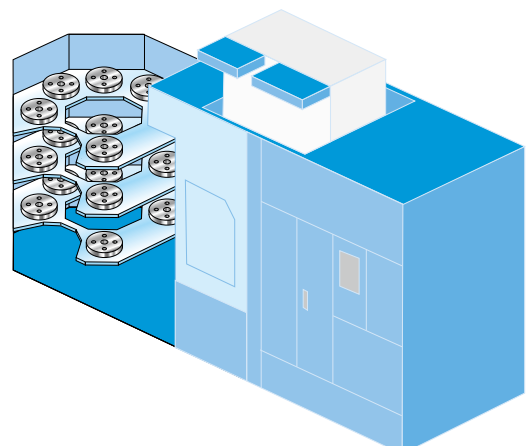

Drum Magazine

Designed & fully proven by Matsuura this new Drum Magazine offers vastly reduced tool change times when compared to conventional designs. Tool indexing time has been reduced by a massive 60%. With less moving parts than standard ATC's, a design imperative from the outset was the elimination of un-necessary noise & vibration.



Drum Magazine

Max. Tool Size [Drum Magazine]

Max. Tool Weight 10kg

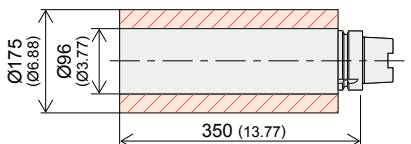

When the pockets on both sides are empty. Ø175 (Ø6.88)

Unit : mm (in.)

HSK-A63W Drum Magazine

51 tools (Fixed Address) Standard

52 tools (Memory Random) Option

HSK-A63W Matrix Magazine

Option

240 base	320 base	520 base
120 tools	120 tools	360 tools
150 tools	160 tools	400 tools
180 tools	200 tools	440 tools
210 tools	240 tools	480 tools
240 tools	280 tools	520 tools
	320 tools	

HSK-A100W Chain Magazine

Option

60 tools	120 tools
----------	-----------

HSK-A100W Matrix Magazine

Option

150 tools	180 tools	210 tools	240 tools
-----------	-----------	-----------	-----------

Matrix Magazine

Option

Offering unparalleled capacity, functionality & reliability Matsuura's Matrix Magazine support the growing global requirement for extended periods of unmanned CNC production. Storage up to 520 tools.

The magazine ceiling guard and the ATC double shutter are provided to prevent coolant from entering the Matrix Magazine. This maintains a much cleaner tool storage environment, especially reducing the amount of coolant grime build up on the tool shanks and drastically improving ATC reliability.



Matrix Magazine (320 base)

Option



A new larger 10 inch screen has been added to the ATC – allowing effortless data control of all aspects of ATC management & functionality.



All Tools



NG Tools



Auto Recovery



All Matsuura ATC's are ergonomically designed for operator comfort & process efficiency. For example high brightness work lights are installed in the Matrix Magazine enclosures.

Max. Tool Size [Matrix Magazine]

Max. Tool Weight 10kg

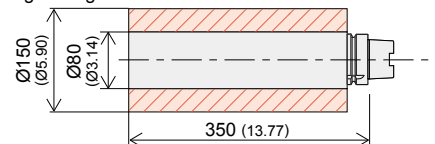

When the pockets on both sides are empty. Ø150 (Ø5.9)

Unit : mm (in.)

High Speed Rotation & High Accuracy Positioning : Matsuura's Unique DD Technology

Ultra Robust DD Turning Spindle Motor

Designed in house by Matsuura, the DD C-Axis Motor achieves high positional accuracy during Milling & high speed rotation whilst Turning.

Horizontal & Vertical Turning

The **CUBLEX-63** turns equally well in either Horizontal or Vertical orientation. The wide X-Axis stroke offers users a significant advantage & opens up new machining possibilities over other multi-tasking machines currently on the market.

Max. Rotation Speed 1,300 min⁻¹

The table C-axis achieves indexing precision of 2 sec^{**}, max rotation speed of 200 min⁻¹ and high positional accuracy in the machining mode. In addition, the max. rotation speed of 1,300 min⁻¹ in the turning mode assures high-speed high-accuracy surface finish.

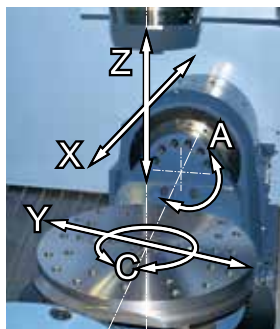

Travels of **CUBLEX-63**

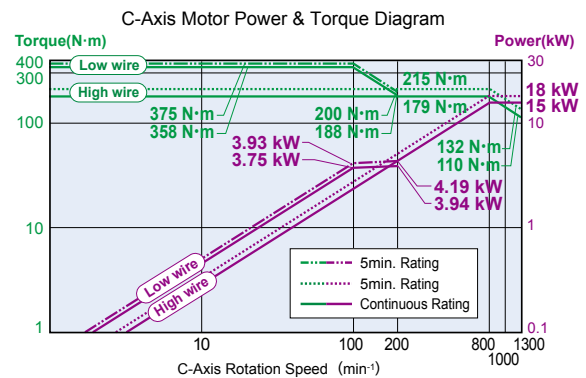

※These are resulting figures, and not guaranteed figures.

Imbalance Check Function

Patented

This function allows the balance of the workpiece to be set before turning. Imbalance in the workpiece during rotation & turning is accurately monitored to prevent problems with unwieldy or uneven components.

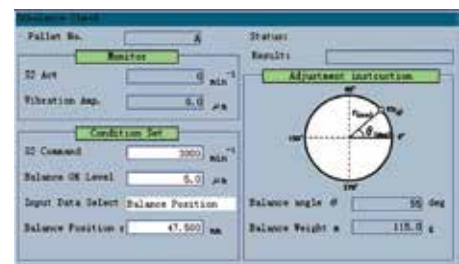

Turning Test Results

	Material	Outer Diameter : D	Cutting Depth/Diameter	Rotation Speed	Feedrate (per rotation)	Quantity
Vertical 	A5057	Ø250 mm (9.84 in.)	6 mm (0.23 in.)	800 min ⁻¹	0.55 mm (0.021 in.)	1036 cc / min
		Ø120 mm (4.72 in.)	9 mm (0.35 in.)	1,300 min ⁻¹	0.45 mm (0.017 in.)	992 cc / min
	S45C	Ø630 mm (24.80 in.)	3 mm (0.11 in.)	155 min ⁻¹	0.18 mm (0.007 in.)	82.5 cc / min
		Ø120 mm (4.72 in.)	9 mm (0.35 in.)	800 min ⁻¹	0.3 mm (0.011 in.)	407 cc / min
Horizontal 	A5057	Ø250 mm (9.84 in.)	6 mm (0.23 in.)	800 min ⁻¹	0.55 mm (0.021 in.)	1036 cc / min
		Ø120 mm (4.72 in.)	9 mm (0.35 in.)	1,300 min ⁻¹	0.45 mm (0.017 in.)	992 cc / min
	S45C	Ø630 mm (24.80 in.)	3 mm (0.11 in.)	155 min ⁻¹	0.18 mm (0.007 in.)	82.5 cc / min
		Ø120 mm (4.72 in.)	9 mm (0.35 in.)	800 min ⁻¹	0.3 mm (0.011 in.)	407 cc / min

※These are resulting data. In some cases, the catalogue data may not be obtained, depending on difference in the conditions.

The Matsuura Hi-Tech Spindle : Designed & Built In-House

Assembled in a Clean Room Environment

Matsuura's Spindle Engineers work in a dedicated Clean Room complex to assure the highest standards of build quality & reliability. Our ultra precision spindles are guaranteed to have a runout of less than 1 μm^* (0.000039 in.) - this is an actual measured value at the spindle nose. *These are resulting figures, and not guaranteed figures.

ICTM-HSK standard

To achieve precision turning, ICTM-HSK standard is used for the spindle taper. For machining operations, standard HSK can be also used.

Maintenance Free & Eco Friendly

The Spindle bearing is lubricated by an automated grease supply system. Low noise operation, with minimum air requirement. Eco friendly & maintenance free.

Spindle Lock System

Matsuura's unique Drum Break locking system is integrated into the spindle to strongly clamp the tool arbitrarily positioned during turning operations. This strong and robust system assures high-accuracy turning.

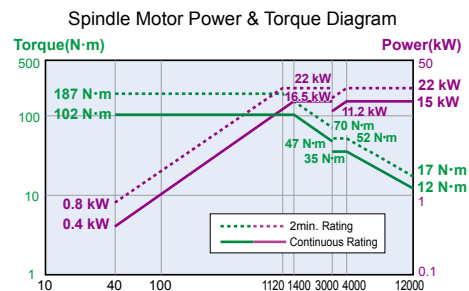

HSK-A100W
10,000min⁻¹ is available.

Option

Machining Test Results

	Material	Tool Details	Cutting Width & Depth	Spindle Speed	Feedrate	Quantity		Material	Tool Details	Spindle Speed	Feedrate	Quantity
 Facemill	A5052	Ø80mm (3.14 in.) 3 tooth	W=70mm (2.75 in.) D=5mm (0.19 in.)	5,500 min ⁻¹	7,000 mm / min (275.59 ipm)	2,450 cc / min	 Drill	A5052	Ø35mm (1.37 in.)	1,500 min ⁻¹	800 mm / min (31.49 ipm)	769 cc / min
	S45C	Ø80mm (3.14 in.) 6 tooth	W=70mm (2.75 in.) D=3mm (0.11 in.)	1,120 min ⁻¹	2,800 mm / min (110.23 ipm)	588 cc / min		S45C	Ø35mm (1.37 in.)	1,500 min ⁻¹	320 mm / min (12.59 ipm)	307 cc / min
 Endmill	A5052	Ø25mm (1 in.) 2 tooth	W=22mm (0.80 in.) D=8mm (0.31 in.)	12,000 min ⁻¹	10,000 mm / min (393.70 ipm)	1,760 cc / min	 Tap	A5052	M36 ×P4.0	120 min ⁻¹	480 mm / min (18.89 ipm)	
	S45C	Ø20mm (0.78 in.) 4 tooth	W=3mm (0.11 in.) D=35mm (1.37 in.)	5,000 min ⁻¹	5,500 mm / min (216.53 ipm)	578 cc / min		S45C	M30 ×P3.5	100 min ⁻¹	350 mm / min (13.77 ipm)	

*These are resulting data. In some cases, the catalogue data may not be obtained, depending on difference in the conditions.

Multi Faceted Tooling

The spindle acts as another axis and can be programmed and locked in any position within 360 degrees. This enables the use of multi-faceted tooling to reduce tool change times and the need for extra tool holders/ pockets. For example, when you use a triple insert cutter the spindle can be locked at 120-degree increments.



Vast Machining Enclosure – Effective & Proven Swarf Management

Matsuura's own unique Flip Up Arm APC

Patented

Matsuura's own & patented Flip Up Arm APC configuration shortens the machine length considerably & significantly reduces the overall machine footprint. Now an established feature on certain twin & multi pallet Matsuura 5-axis product lines, this APC design has proven itself to be one of the most reliable & trouble free currently available on the market.



X-Type APC Door

Utility Model

- Featured only on Matsuura products, our X-Type APC door design removes all opportunity for swarf to build up & become trapped, eventually causing machine downtime.
- This exclusive Matsuura X-Type Door design still maintains the **CUBLEX-63**'s largest in class working envelope & workpiece accommodation.

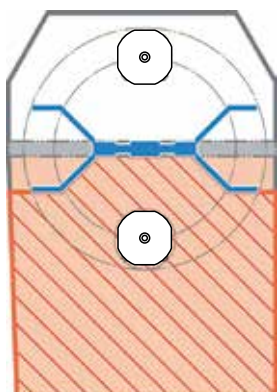

X-type APC Door



W-Type Slide Cover

By integrating steep angled steel Z-Axis covers, swarf is efficiently directed into 2 gutters, where standard spiral chip conveyors rapidly transport waste material out of the enclosure. To accommodate high volumes of metal removal of all types, a wide variety of swarf management system designs are available.

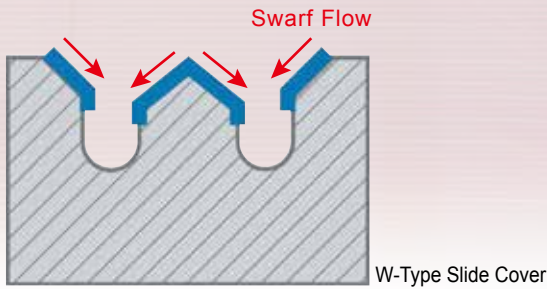

Lift-Up Chip Conveyors

Option

Scraper Type

- Drum Filter
- Oily Coolant Applicable (less than 10 cSt)

Hinge Type

- Drum Filter
- Only Water Solution Coolant Applicable

Thermal Meister™

Patented

Thermal Meister™ monitors the temperature of the spindle and the X, Y and Z axes and supplies a constant feed of compensation values to the NC to maintain assured accuracy.

Tailstock Unit

Option



Broken Tool Detection/Auto Tool Length Measurement (Laser Sensor)

Option



※Compound expression (Touch Sensor&Laser Sensor)

State of the Art NC for Complex Data Processing

Realized the latest high efficiency NC control

Matsuura G-Tech 30i

- High speed CPU and FSSB, internal CNC bus, optical fiber cables used for high speed data transfer.
- Nanometer resolution.
- 10.4 inch color LCD, Compact Flash Port, PC file management structure.

For High Speed and Finer Machined Surface

For General Parts or Molds	Standard
IZ-1 / 15F	

Complex Shaped Parts or Precise Molds (Look Ahead Linear Acc./dec.+ Nano interpolation)	Option
IZ-1 / 30NF, IZ-2 / 150NF	

Executing the max. 200(IZ-1/30NF) or 600*(IZ-2/150NF) - block look ahead linear acc./dec. before interpolation achieves a smooth acc./dec. across the multiple blocks calculated by nano order.

※max.1,000 block available as option.



Human Machine Interface

Standard

Handy Man II

Handy Man II provides major savings by reducing set-up, programming, operating & maintenance times.



High-Speed Precision

Machining Program Support Function

Standard

IPC

When utilizing this software, setting the required part accuracy level is quick, simple and user friendly, allowing you to prioritize precision against speed.

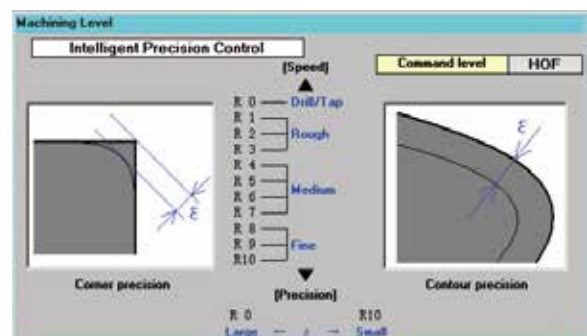

High-speed, high-precision 5-axis package

Option

Packages of NC Software, tailored to your production, are available.
Please consult your Matsuura dealer for full details & assessment of your requirements.

Automatically Controlled Toolpath / Tool Speed

TCPC

5-Axis Transformation is the kinematic transformation function of **G-Tech 30i** which realizes easy tool center point programming for 5-Axis machining. The path and path velocity of the tool center point, can be programmed based on the workpiece coordinate system, in the same way as that for 3-Axis machine tools.

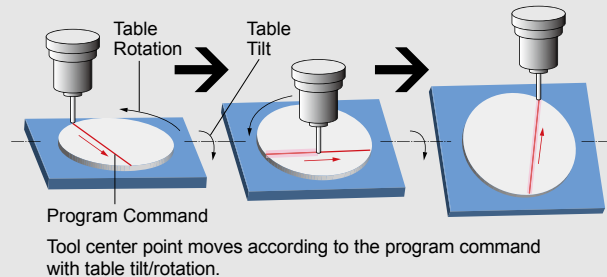

Easy Programming (3+2-Axis)

Tilted Working Plane Command(TWP)

G-Tech 30i offers, as standard feature, **Tilted Working Plane Command(TWP)** which takes over necessary calculations of coordinate values including necessary axes motions. When rotary axes are moved, complex calculations, in line with machine axes configuration, should be made for re-calculating and establishing suitable work coordinate system for the new surface & its orientation.

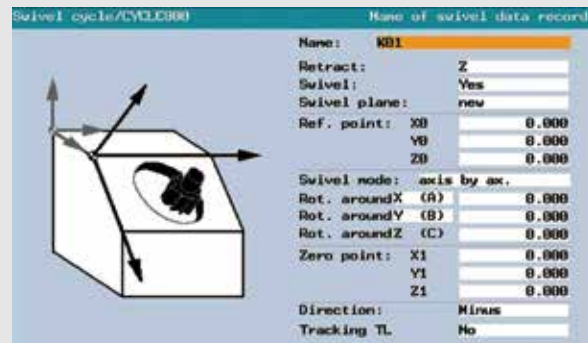

Tool Diameter Interpolations on 5-Axis

Three Dimensional Cutter Compensation

Three Dimensional Cutter Compensation sets the value of tool-offsets automatically for simultaneous 5-Axis machining according to the pre-set value. It enables the safe & automatic use of different diameter tools during 5-Axis machining with the table tilted.

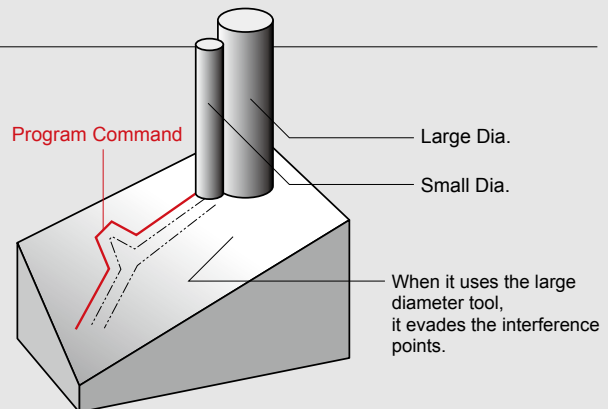

Effortless G-Code Functionality

Standard

Changing G-Codes is quick & simple.

Mode	G-Code
Milling	G300
Turning (Vertical)	G301
Turning (Horizontal)	G302
Grinding (Option)	G303

Specifications

■ Movement and Ranges		
X-Axis Travel	mm (in.)	760
Y-Axis Travel	mm (in.)	845
Z-Axis Travel	mm (in.)	660
A-Axis Travel	deg	-120 ~ +30
C-Axis Travel	deg	360
■ Pallet		
Working Surface	mm (in.)	Ø500 (Ø19.68)
Loading Capacity	kg (lb.)	350 (770)
Max. Work Size	mm (in.)	Ø630 × H450 (Ø24.80 × H17.71)
■ Spindle		
Spindle Speed Range	min ⁻¹	40 ~ 12,000
Type of Spindle Taper Hole		HSK-A63W (ICTM)
Spindle Bearing Inner Diameter	mm (in.)	Ø80 (Ø3.14)
Max. Spindle Torque	N·m/min ⁻¹	187 / 1,120
Spindle Drive Motor	kW (HP)	15 / 22 (30)
■ Feedrate		
Rapid Traverse Rate (X/Y/Z)	mm/min (ipm)	60,000 (2,362.20)
Rapid Traverse Rate (A)	min ⁻¹	25
Rapid Traverse Rate (C : Milling/Turning)	min ⁻¹	200 / 1,300
Min. Movement Increment (X/Y/Z)	mm (in.)	0.001 (0.000039)
Min. Movement Increment (A/C)	deg	0.001
■ Automatic Tool Changer		
Type of Tool Shank		HSK-A63W (ICTM)
Tool Storage Capacity		51 (Drum Magazine)
Max. Tool Diameter	mm (in.)	Ø96 (Ø3.77) When the pockets on both sides are empty Ø175 (Ø6.88)
Max. Tool Length	mm (in.)	350 (13.77)
Max. Tool Mass	kg (lb.)	10 (22)
Method of Tool Selection		Fixed Address
Tool Change Arm		Double Grip Type
Tool Changing Time (Tool to Tool)	sec	1.1 (Target value)
Tool Changing Time (Chip to Chip)	sec	5.0

■ Automatic Pallet Changer		
Number of Pallets	pcs	2
Methods of Pallet Change		Rotary Type
Pallet Changing Time (pallet to pallet)	sec	19 (Target value)
Pallet Clamping Force	kN	41.5
Pallet Weight / 1 Pallet	kg (lb.)	95
■ Power Sources		
Power Capacity	kVA	98
Input Power	V	AC 200 / 220 ±10%
Frequency Required	Hz	50 / 60 ±1
Air Source	MPa	0.54 ~ 0.93
Volume of Compressed Air	Nl/min	50
■ Machine Size		
Machine Weight	kg (lb.)	15000 (33000)
■ Tank Capacity		
Hydraulic Oil Tank Capacity	L	40
Coolant Tank Capacity	L	600
■ Standard Accessories		

- | | |
|--|---|
| 01. Total Splash Guard | 02. ATC Auto Door |
| 03. Work Station for PC2 | 04. Safety Cover for Work Station |
| 05. Synchronized Tapping | 06. AD-TAP Function |
| 07. IPC Function | 08. Spindle Oil Cooler |
| 09. C-Axis Oil Cooler | 10. Auto Grease Supply Unit |
| 11. Coolant Unit | 12. Spiral Chip Conveyor |
| 13. Chip Flush | 14. Movable Manual Pulse Generator |
| 15. Spindle Overload Protect | 16. Workpiece Counter (9 sorts of M Function) |
| 17. Thermal Meister™ | 18. Work Light |
| 19. Machine Color Paint | 20. Handy Man II |
| 21. Standard Mechanical Tools & Tool Box | |
| 22. Levelling Pads & Bolts (Not utilized for the foundation) | |
| 23. Scale Feedback for the A/C-Axis | |
| 24. Imbalanced Check Function | |
| 25. Matsuura Safety Specification | |

* 2 years spindle warranty

Outline

Unit : mm (in.)

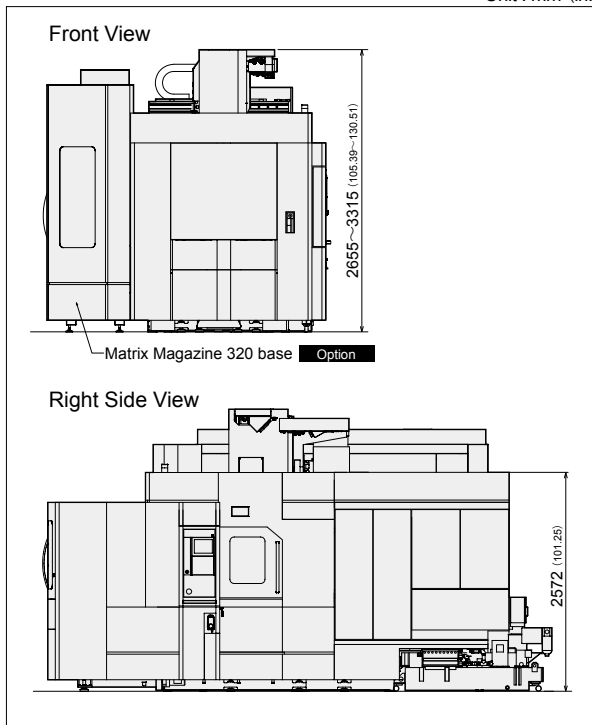

Floor Plan

Unit : mm (in.)

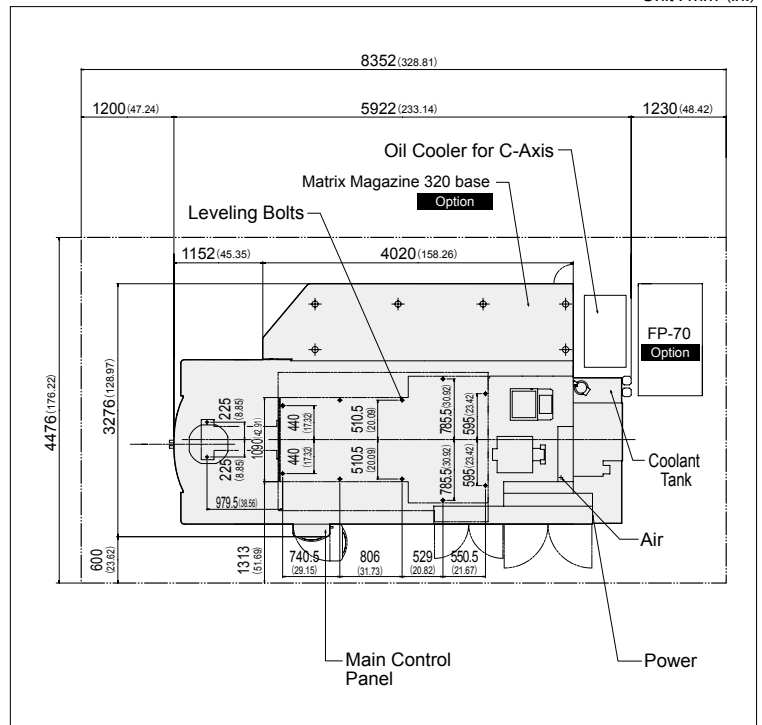

Equipment

○:Standard ▲:Option

■ Spindle	
12,000 min ⁻¹ (HSK-A63W, Grease Lubrication)	○
10,000 min ⁻¹ (HSK-A100W, Grease Lubrication)	▲
20,000 min ⁻¹ (HSK-A63W, Auto Grease Lubrication)	▲
■ ATC	
□ HSK-A63W	
51 tools (Drum Magazine Fixed Address)	○
52 tools (Drum Magazine Memory Random)	▲
120 / 150 / 180 / 210 / 240 tools (Matrix Magazine 240 base)	▲
120 / 160 / 200 / 240 / 280 / 320 tools (Matrix Magazine 320 base)	▲
360 / 400 / 440 / 480 / 520 tools (Matrix Magazine 520 base)	▲
□ HSK-A100W	
60 tools (Chain Magazine)	▲
120 / 150 / 180 / 210 / 240 tools (Matrix Magazine 240 base)	▲
270 / 300 / 330 / 360 tools (Matrix Magazine 320 base)	▲
■ High Accuracy Control	
Scale Feedback A-Axis	○
Scale Feedback C-Axis	○
Scale Feedback X / Y-Axis	▲
Scale Feedback Z-Axis	▲
Scale Feedback X / Y / Z-Axis	▲
■ APC	
PC2	○
PC6 (Floor Pallet System)	▲
PC18 (Tower Pallet System)	▲
PC17~ (Linear Pallet System)	▲
■ Coolant	
Coolant unit	○
Coolant Thru Spindle Vacuum Type Coolant Thru A	▲
Coolant Thru Spindle Vacuum Type Coolant Thru B	▲
Coolant Thru Spindle Vacuum Type Coolant Thru C (2 MPa)	▲
Coolant Thru Spindle Vacuum Type Coolant Thru C (7 MPa)	▲
Coolant Flow Checker	▲
Coolant Temperature Controller Separate Type, 100L Tank	▲
Coolant Temperature Controller Separate Type, 200L Tank	▲
Coolant shower system	▲
Air blow for chip removal	▲

■ Swarf Management	
Total Splash Guard	○
ATC Auto Door	○
Spiral Chip Conveyor	○
Chip Flush System	○
External Nozzle 2 MPa with Spindle Thru	▲
External Nozzle 7 MPa with Spindle Thru	▲
Lift-Up Chip Conveyor (Scraper, Drum)	▲
Lift-Up Chip Conveyor (Hinge, Drum)	▲
Chip Bucket	▲
Workpiece Cleaning Gun (Machine Side)	▲
■ Operation & Maintenance Support	
AD-TAP Function	○
IPC Function	○
Handy Man II	○
Grease Supply Unit for the Guideway	○
Work Light	○
Movable Manual Pulse Generator	○
8 Sets of Extra M Function	▲
Spindle Load Monitoring Function	▲
Weekly Timer	▲
Spindle Run Hour meter	▲
Rotary Wiper (Air Supply System)	▲
Rotary Wiper (Electrical System)	▲
Automatic Operation Run Hour Display Unit	▲
Optional Block Skip 2~9	▲
Program End Announcement Light (Red, Yellow, Green)	▲
Tail Stock	▲
■ Safety Regulation	
Matsuura Safety Specification	○
■ In-Process Measurement + Tool Breakage	
In-Process Measurement/Auto Centering (Optical Touch Probe)	▲
Broken Tool Detection/Auto Tool Length Measurement (Touch Sensor)	▲
Broken Tool Detection/Auto Tool Length Measurement (Laser Sensor)	▲
In-Process Measurement (Optical Touch Probe) & Broken Tool Detection (Touch Sensor)	▲
In-Process Measurement (Optical Touch Probe) & Broken Tool Detection (Laser Sensor)	▲
In-Process Measurement (Optical Touch Probe) & Broken Tool Detection (Compound expression)	▲
■ Grinding Function	
Grinding Function A	▲
Grinding Function B	▲
■ Optional Package	
TRUE PATH	▲
Machine module	▲

Pallet Surface

Unit : mm (in.)

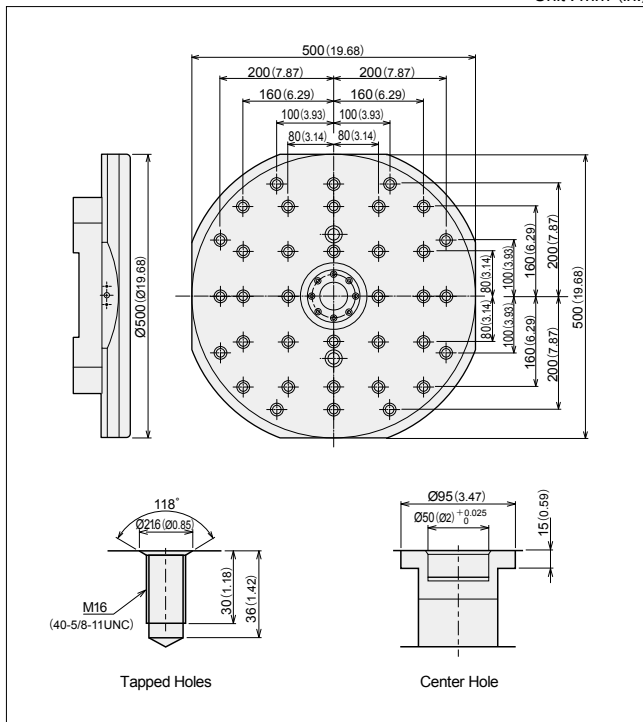

Optional Grinding Functions Option

Grinding is achieved by rotating the C-Axis of 1,300 min⁻¹ and the spindle with a grindstone of 12,000 min⁻¹ at the same time.

Providing 2 Type (A/B) Grinding Functions

- **Type A [Basic Option]**
 - Y-Axis dust control cover, External nozzle, Chopping function
- **Type B [Filtering Ability 5 μm (0.000196 in.)]**
 - Type A
 - + 7 MPa coolant thru spindle + Oil temperature controller



Matsuura

URL : <http://www.matsuura.co.jp/>

E-MAIL : webmaster@matsuura.co.jp

MATSUURA MACHINERY CORPORATION

1-1 Urushihara-cho Fukui City 910-8530, Japan

TEL : +81-776-56-8106 FAX : +81-776-56-8151

MATSUURA EUROPE GmbH

Berta-Cramer-Ring 21

D-65205 Wiesbaden-Delkenheim, Germany

TEL : +49-6122-7803-80 FAX : +49-6122-7803-33

URL : <http://www.matsuura.de/>

E-MAIL : info@matsuura.de

MATSUURA MACHINERY Ltd.

Gee Road, Whitwick Business Park, Coalville Leicestershire, LE67 4NH, England

TEL : +44-1530-511-400 FAX : +44-1530-511-440

URL : <http://www.matsuura.co.uk/>

E-MAIL : sales@matsuura.co.uk

Facebook : www.facebook.com/pages/Matsuura-Machinery-Ltd/427006380682983

MATSUURA MACHINERY GmbH

Berta-Cramer-Ring 21

D-65205 Wiesbaden-Delkenheim, Germany

TEL : +49-6122-7803-0 FAX : +49-6122-7803-33

URL : <http://www.matsuura.de/>

E-MAIL : info@matsuura.de

ELLIOTT MATSUURA CANADA INC.

2120 Buckingham Road Oakville Ontario L6H 5X2, Canada

TEL : +1-905-829-2211 FAX : +1-905-829-5600

URL : <http://www.elliottmachinery.com/>

E-MAIL : sales@elliottmachinery.com

MATSUURA MACHINERY USA INC.

325 Randolph Ave., St.Paul, MN 55102, U.S.A.

TEL : +1-651-289-9700

URL : <http://www.matsuurausa.com/>

E-MAIL : info@matsuurausa.com

-
- Product specifications and dimensions are subject to change without prior notice.
 - The photos may show optional accessories.



This product is subject to all applicable export control laws and regulations

