

MX-520



URL : <http://www.matsuura.co.jp/>
E-MAIL : webmaster@matsuura.co.jp

MATSUURA MACHINERY CORPORATION
4-201 Higashimorida, Fukui-City 910-8530 Japan
TEL : +81-776-56-8106 FAX : +81-776-56-8151

MATSUURA EUROPE GmbH
Berta-Cramer-Ring 21
D-65205 Wiesbaden-Delkenheim, Germany
TEL : +49-6122-7803-80 FAX : +49-6122-7803-33
URL : <http://www.matsuura.de/>
E-MAIL : info@matsuura.de

MATSUURA MACHINERY Ltd.
Gee Road, Whitwick Business Park, Coalville Leicestershire, LE67
4NH, England
TEL : +44-1530-511-400 FAX : +44-1530-511-440
URL : <http://www.matsuura.co.uk/>
E-MAIL : sales@matsuura.co.uk

MATSUURA MACHINERY GmbH
Berta-Cramer-Ring 21
D-65205 Wiesbaden-Delkenheim, Germany
TEL : +49-6122-7803-0 FAX : +49-6122-7803-33
URL : <http://www.matsuura.de/>
E-MAIL : info@matsuura.de

ELLIOTT MATSUURA CANADA INC.
2120 Buckingham Road Oakville Ontario L6H 5X2, Canada
TEL : +1-905-829-2211 FAX : +1-905-829-5600
URL : <http://www.elliottmachinery.com/>
E-MAIL : sales@elliottmachinery.com

MATSUURA MACHINERY USA INC.
325 Randolph Ave., St.Paul, MN 55102, U.S.A.
TEL : +1-651-289-9700
URL : <http://www.matsuurausa.com/>
E-MAIL : info@matsuurausa.com

- Product specifications and dimensions are subject to change without prior notice.
- The photos may show optional accessories.



This product is subject to all applicable export control laws and regulations





MAXIA
Innovation by Matsuura

Our best-selling single table 5 axis machine has just got even better; enhanced performance, optimized production and introducing our own PC4 automation package

Introduced to offer aspirational companies the chance to invest in a hand-built *Matsuura* 5 axis machine, the single table *MX-520* has been nothing short of a phenomenal success for *Matsuura* and our customers

Operator door opening width 800mm (31.49in.)

Floor to table top surface 850mm (33.46in.)
(Pallet specification 870mm (34.25in.))

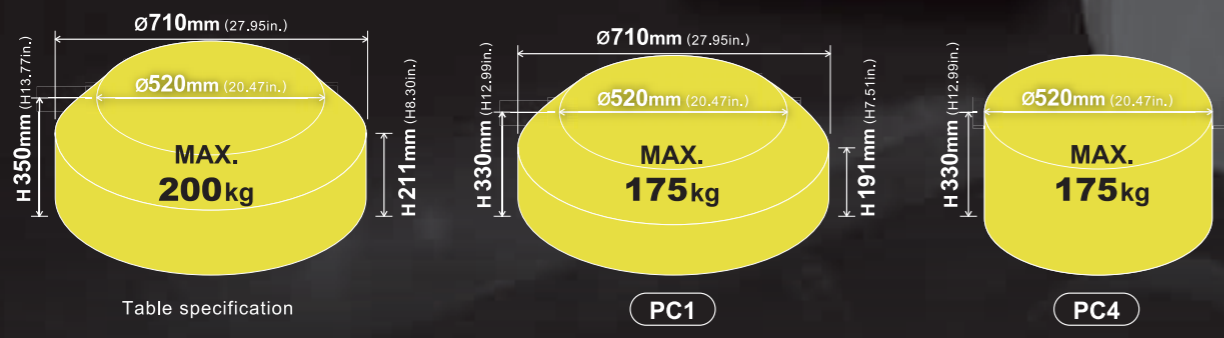

X-axis stroke	630mm (24.8in.)
Y-axis stroke	560mm (22.04in.)
Z-axis stroke	510mm (20.07in.)
A-axis rotation angle	-125~+10deg
C-axis rotation angle	360deg

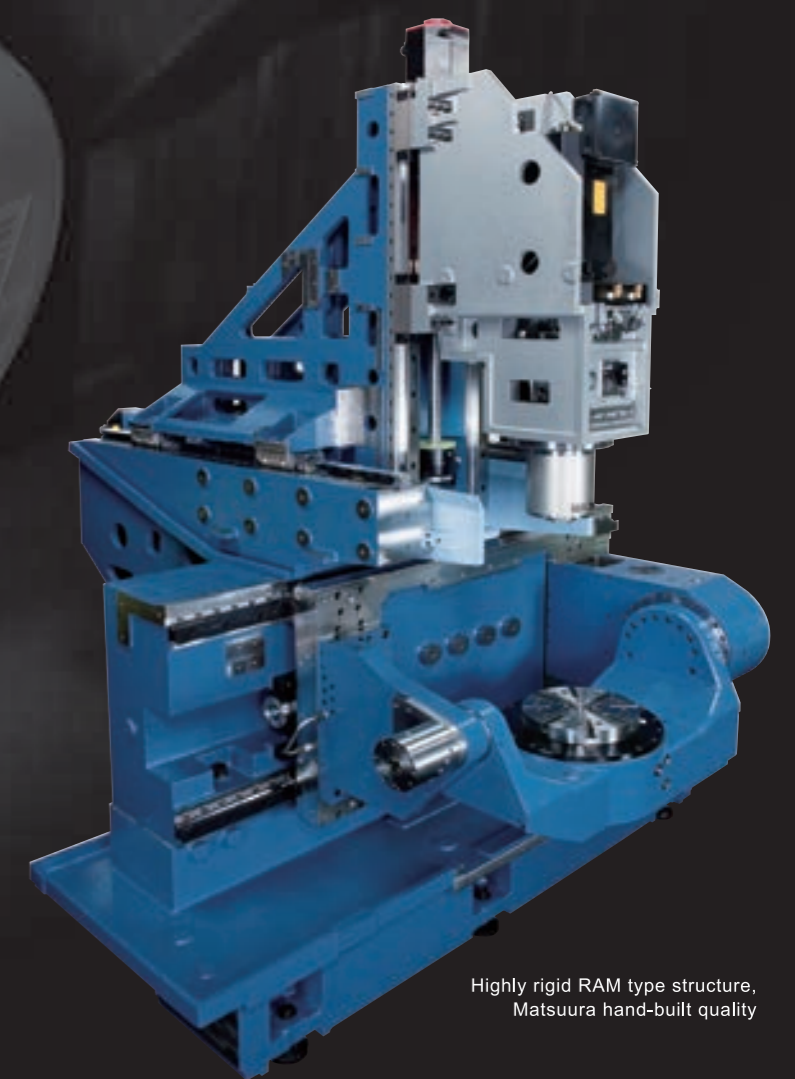

By customer demand, we present our OEM PC4 automation package; designed and built by **Matsuura**



Automation & Unmanned Package Option



PC4 + 90-tool magazine



Ready for “IoT”

Matsuura IoT is an open source platform, enabling the sharing of information from numerous machines to your production monitoring systems. Remote “status at a glance” visualization of current machine status maximizes and optimizes process efficiency and unmanned production whilst countering unscheduled maintenance and downtime.

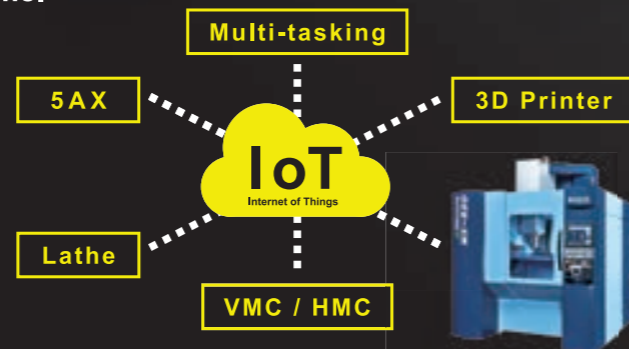

ø400-mm pallet specification

MX-520 5-Axis Vertical Machining Center

[Automation]

Affordable, Reliable Unmanned 5 Axis Production Unmanned Automation Package Option

Matsuura designed and built compact OEM 4 pallet system, with 90 tools as standard for maximum production and optimized spindle utilisation.

Excellence is affordable; The MX-520 **PC4** delivers our legendary 5 axis automated production to within the investment reach of all machining companies.

Automation Package

Compact-design automated system

Option

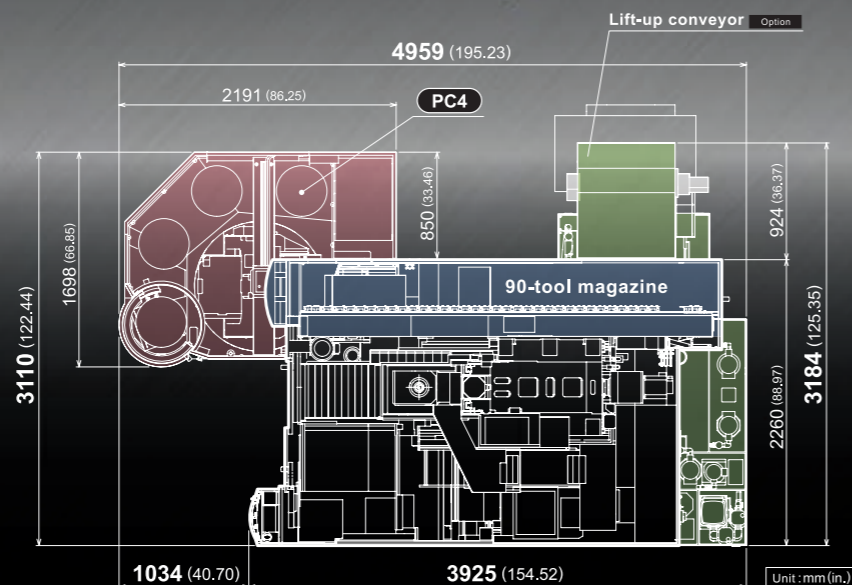
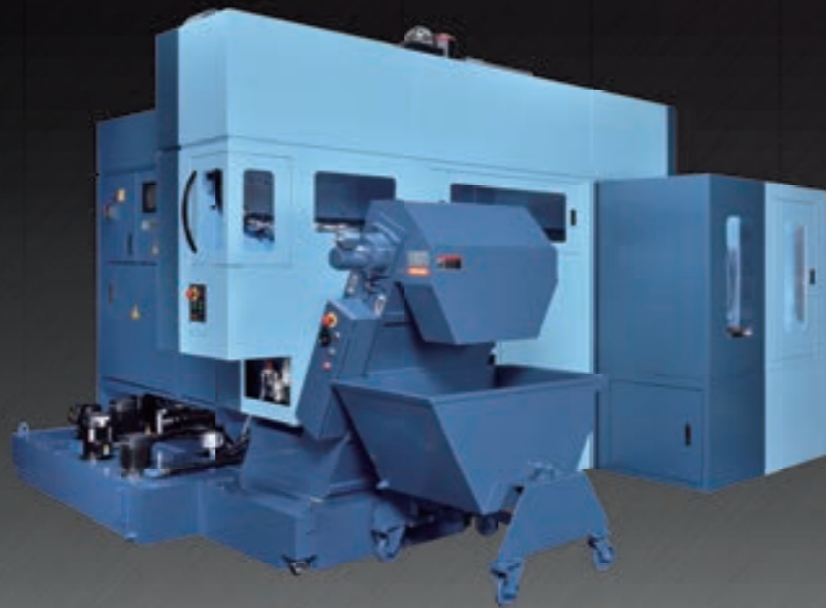

Work station

Large opening ensures good access to the workpiece.



Spiral conveyor

30% higher transfer capacity than conventional models



90-tool magazine



Three-port pressure supply system to fixtures

Option

Equipped with pressure supply ports for through-palletsystem fixtures. Supports pressures of up to 19.6 MPa.

Work station (rotary)

Option

Assisting set-up by rotating the workstation by 90 degree increments.

PC4

Pallet storage: Memory random system

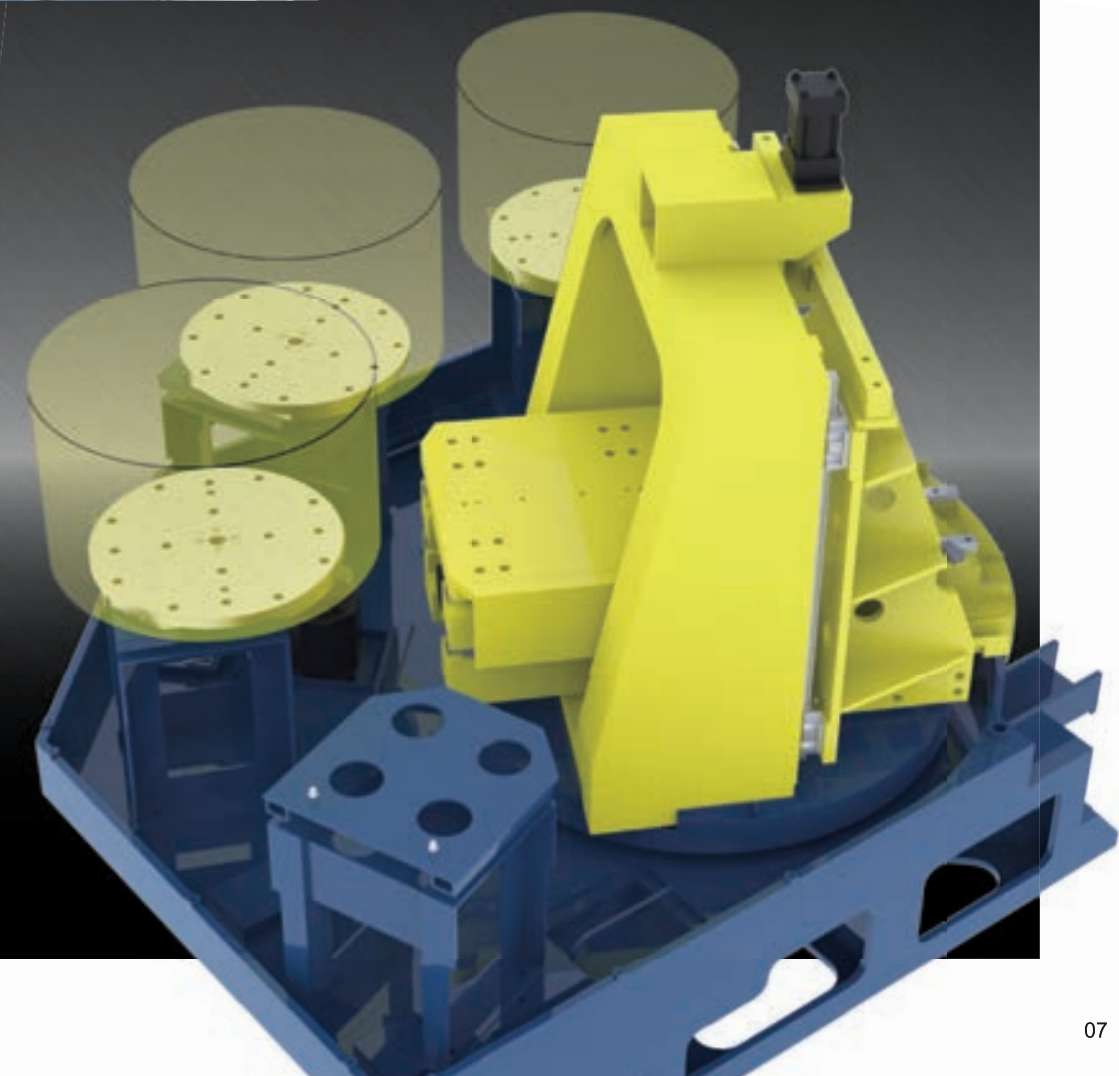

MX-520 5-Axis Vertical Machining Center

[Operability]

Maximum functionality and optimised performance Easy Operation

Our latest NC is our most powerful yet, delivering fast access touch screen usability with a refined ergonomic & logical layout



Matsuura G-Tech 31i

MIMS

Matsuura Intelligent Meister System

Secure

Reliability Meister

Reduced machine downtime

- Preventive maintenance support function
- Machine recovery support function
- Electronic manual function ■ E-mail transmission function

Simple

Operability Meister

Hassle-free, simple operation

- Tool setup support
- Workpiece setup support

Accuracy

Thermal Meister

Stable accuracy

- Spindle thermal displacement compensation Option
- Environmental thermal displacement compensation Option

Environment

Eco Meister

Eco mode

Power savings

- Power cut-off function
- Energy-saving devices installed
- Eco-operation

Intelligent Protection System

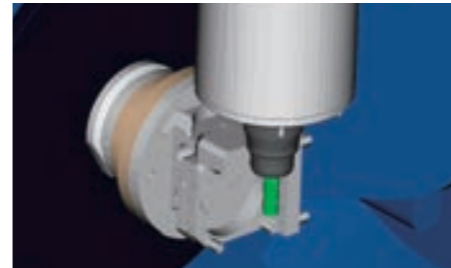

Collision prevention function Standard

This collision protection function is developed solely by Matsuura. It prevents machine collisions due to programming errors in automatic operation, and also prevents human error in advance during manual operation and workpiece setup.

■ On-line link with PC



PC



Machining center

The **Intelligent Protection System** simulates your programmed components (tools, workpiece, fixtures, etc.) that match the machine model, alerting you to any possible interference or collision before actual machining takes place.
* Prepare a PC on your side. Contact Matsuura for PC requirements.

Synchro Tip + Orbit machining Patent No. 5883535 Option

Simple turning function combining orbit machining and C-axis rotation

Turning processes can also be performed on this machining center by using a synchro chip. Since turning and machining can now be done in one process no additional setup time is required for the turning process.

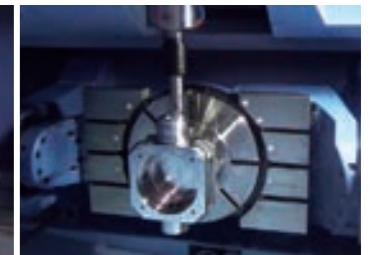
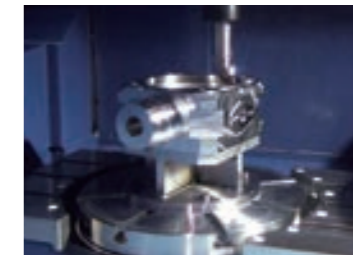

* **Synchro Tip** (Orbit machining + C-axis rotation) * Orbit function

eZ-5 Option

Advanced 5-axis error measurement and correction

Geometric error correction is essential for multi-axis machine tools. eZ-5 completes measurement, using a touch probe and calibration sphere, in a mere 3 minutes. The high accuracy of the machine is maintained through quick and simple operations.
* eZ-5 requires a separately available NC option to add macro variables

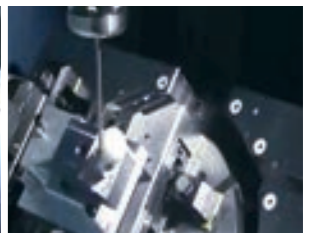

Operation Panel

FANUC 31i (iHMI, 15-inch touch panel type)
Usability is drastically upgraded with context-sensitive screen icons and quick screen displays.



Program management



Tool offset



Electronic manual display

MX-520

[Spindle]

High-rigidity, high-precision MAXIA BT40 Spindle

MAXIA spindle for a wide range of materials from steel to aluminum
Spindle runout less than 1 μm at spindle end.

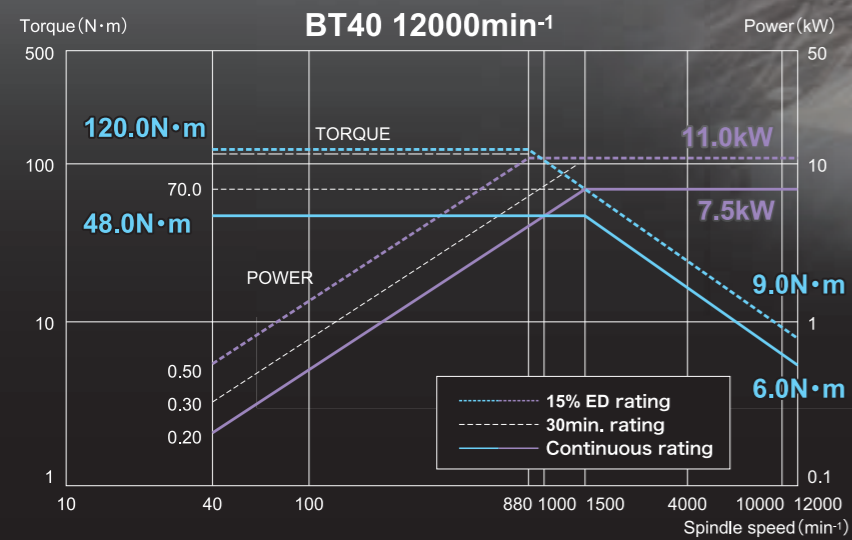

The headstock & trunnion configuration has been designed in such a way as to minimise the possibility of collision, whilst maximising tool access & reach.

Option BT40 12000min⁻¹ Power UP

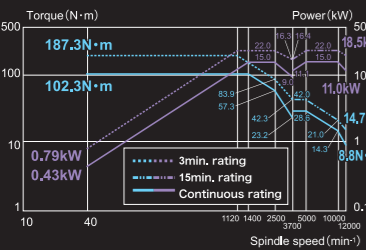

Option BT40 20000min⁻¹

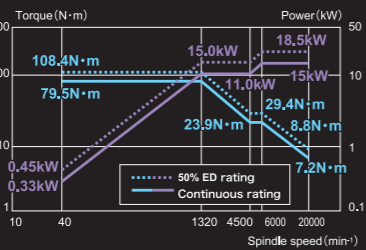

MX-520

[Table / Tool / Swarf Management]

Select According to Your Application

Select your table from Ø300-mm, Ø500-mm, Ø300-mm + flat table type.
A 6-port through-table circuit is also available.

Table specification

Ø300mm

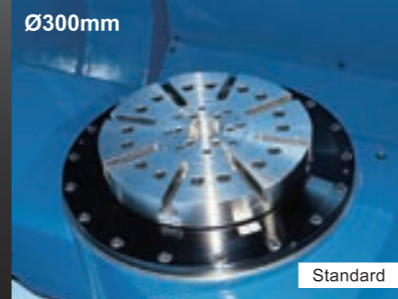

Ø500mm

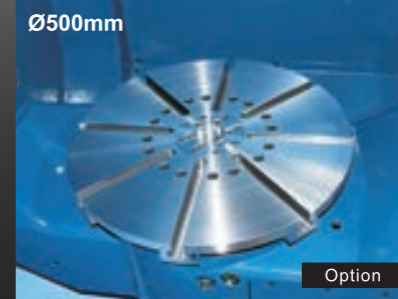

Ø300mm + Flat Table

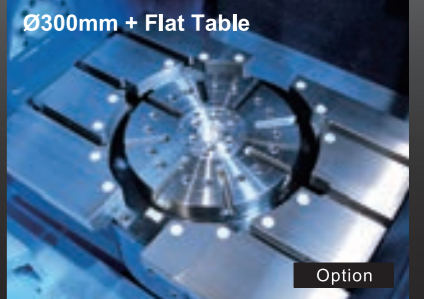

6-port through-table (Max. supply pressure 19.6MPa)

Option

Tool specification

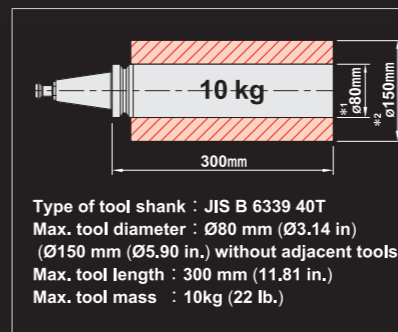

60-tool magazine

Standard



90/120-tool magazine

Option

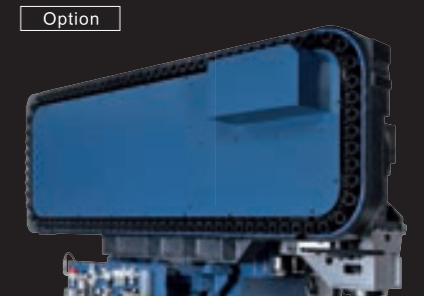

Spindle Stroke Diagram (Table specification)

Unit : mm (in.)

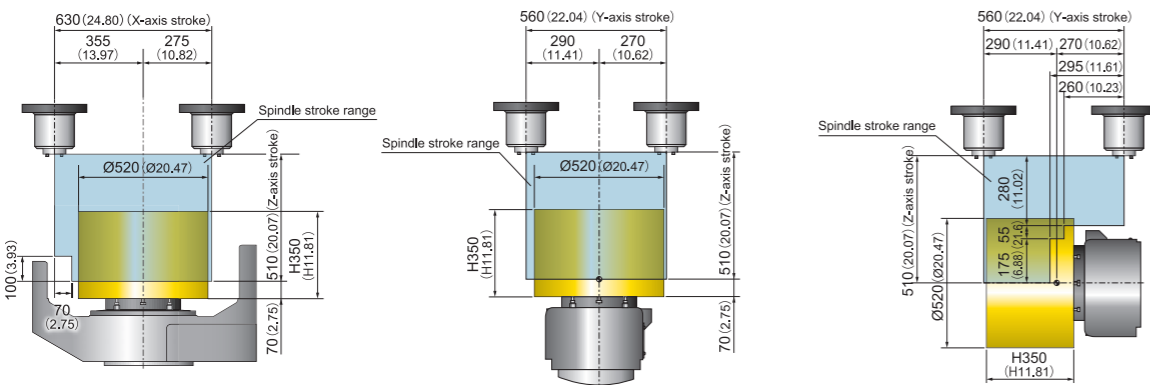

* Table size: Ø300 mm (Ø11.81 in.), X-axis 0 to -560 mm (-22.04 in.)

Smooth Chip Removal

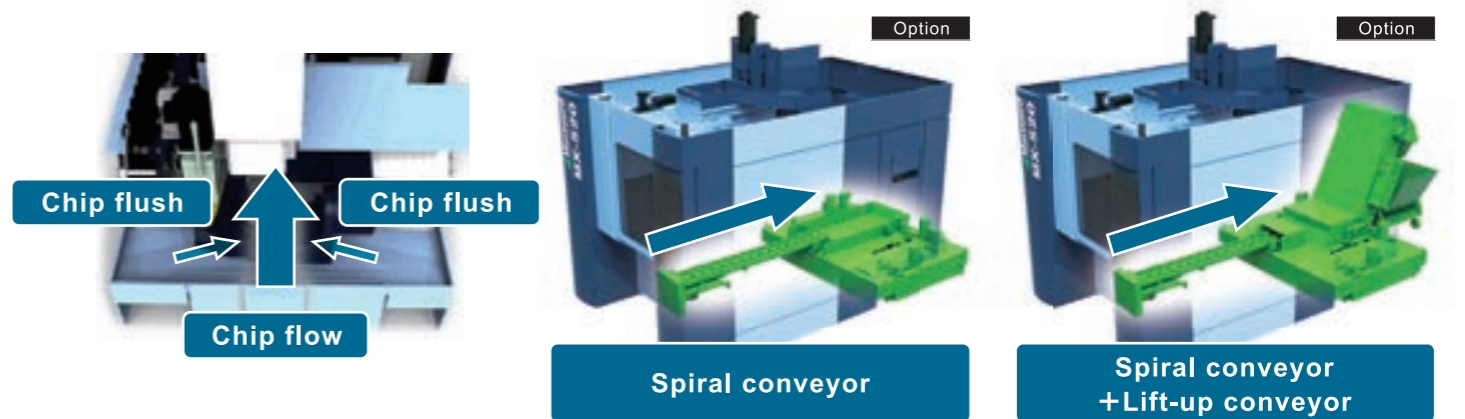

MX-520

[Manufacturing samples]



Multiple-part machining with PC4

Valve Block (Aircraft Part)

An example of lot production of multiple-part machining. A wide machining area is provided in a compact machine frame. Simple automation enable scheduled operation during nighttime for running 24 hours without stopping.

[Material]	A5052
[Dimensions]	150×100×100 (mm) (5.90×3.93×3.93 in.)



Simultaneous 5-axis machining

Wheel (Prototype Part)

High-speed machining of aluminum with a high-speed spindle of 20,000 min⁻¹. Simultaneous 5-axis machining is available on the MX-520 model by standard. The program is created from 3D data through CAM. Machining in the depth of the workpiece is possible with a wide tilting range and good accessibility between the spindle and the table.

[Material]	A5052
[Dimensions]	Ø500×80 (mm) (Ø19.68×3.14 in.)

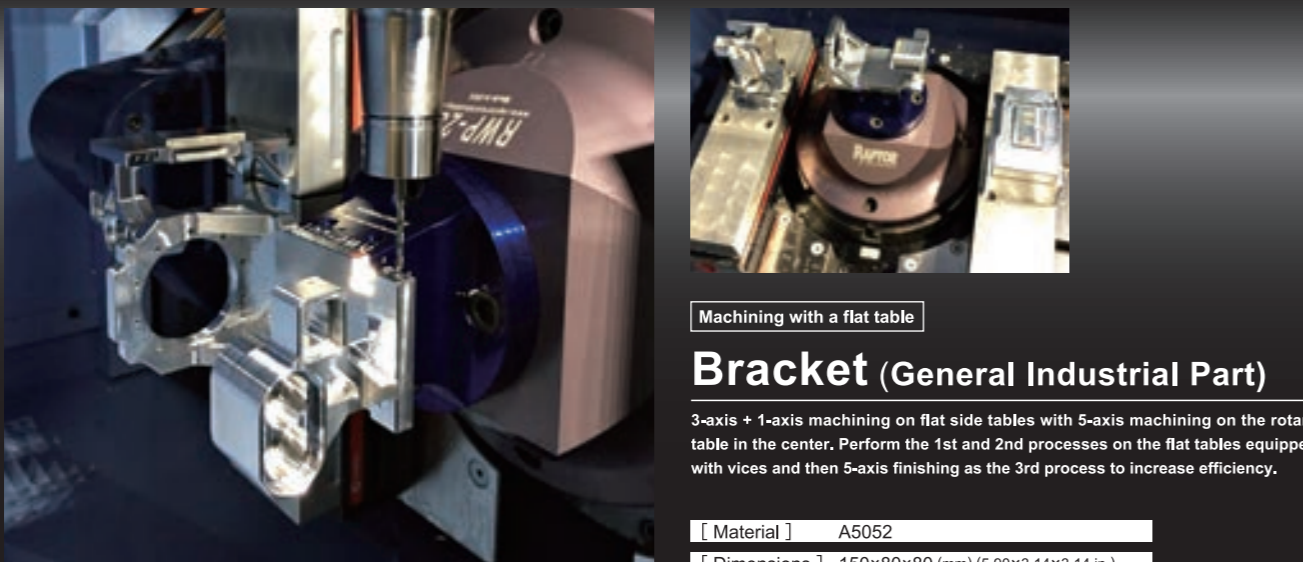

Machining with a flat table

Bracket (General Industrial Part)

3-axis + 1-axis machining on flat side tables with 5-axis machining on the rotary table in the center. Perform the 1st and 2nd processes on the flat tables equipped with vices and then 5-axis finishing as the 3rd process to increase efficiency.

[Material]	A5052
[Dimensions]	150×80×80 (mm) (5.90×3.14×3.14 in.)



5-face indexing with single setup

Valve (Automobile Part)

One-hit machining achieved the complex shaped prototype. Simplified machining process by combination of Tilted Working Plane Command & Tool Center Point Control. Using the simple jig enables 46 faces index machining and reduce the jig cost significantly.

[Material]	A5056
[Dimensions]	Ø100×74 (mm) (Ø3.93×2.91 in.)

Machining test results

BT#40 12000min⁻¹ (120N·m) Standard

	Part material	Tool size	Cutting width Cutting depth	Spindle speed	Cutting feed rate	Cutting capacity		Part material	Tool size	Spindle speed	Cutting feed rate	Cutting capacity
Face mill	A5052	Ø80mm (3.14) 3 blades	W=70mm (2.75) D=4mm (0.15)	5500 min ⁻¹	4000 mm/min (157.48)	1120 cc/min	U Drill	A5052	Ø33mm (1.29)	1200 min ⁻¹	500 mm/min (19.68)	427 cc/min
	S45C	Ø80mm (3.14) 5 blades	W=70mm (2.75) D=3mm (0.11)	900 min ⁻¹	1800 mm/min (70.86)	378 cc/min		S45C	Ø33mm (1.29)	1200 min ⁻¹	220 mm/min (8.66)	188 cc/min
End mill	A5052	Ø25mm (0.98) 2 blades	W=22mm (0.86) D=6mm (0.23)	12000 min ⁻¹	7000 mm/min (275.59)	924 cc/min	Tap	A5052	M30 ×P3.5	120 min ⁻¹	420 mm/min (16.53)	—
	S45C	Ø20mm (0.78) 4 blades	W=3mm (0.11) D=30mm (1.18)	5000 min ⁻¹	3000 mm/min (118.11)	270 cc/min		S45C	M24 ×P3.0	100 min ⁻¹	300 mm/min (11.81)	—

BT#40 12000min⁻¹ (187.3N·m) Option

	Part material	Tool size	Cutting width Cutting depth	Spindle speed	Cutting feed rate	Cutting capacity		Part material	Tool size	Spindle speed	Cutting feed rate	Cutting capacity
Face mill	A5052	Ø80mm (3.14) 3 blades	W=70mm (2.75) D=5mm (0.19)	5500 min ⁻¹	7000 mm/min (275.59)	2450 cc/min	U Drill	A5052	Ø35mm (1.37)	1500 min ⁻¹	800 mm/min (31.49)	769 cc/min
	S45C	Ø80mm (3.14) 5 blades	W=70mm (2.75) D=3mm (0.11)	1120 min ⁻¹	2800 mm/min (110.23)	588 cc/min		S45C	Ø35mm (1.37)	1200 min ⁻¹	320 mm/min (12.59)	308 cc/min
End mill	A5052	Ø25mm (0.98) 2 blades	W=22mm (0.86) D=8mm (0.31)	10000 min ⁻¹	10000 mm/min (393.70)	1760 cc/min	Tap	A5052	M36 ×P4.0	120 min ⁻¹	480 mm/min (18.89)	—
	S45C	Ø20mm (0.78) 4 blades	W=3mm (0.11) D=35mm (1.37)	5000 min ⁻¹	5500 mm/min (216.53)	578 cc/min		S45C	M30 ×P3.5	100 min ⁻¹	350 mm/min (13.77)	—

BT#40 20000min⁻¹ (108.4N·m) Option

	Part material	Tool size	Cutting width Cutting depth	Spindle speed	Cutting feed rate	Cutting capacity		Part material	Tool size	Spindle speed	Cutting feed rate	Cutting capacity
Face mill	A5052	Ø80mm (3.14) 3 blades	W=70mm (2.75) D=4mm (0.15)	5500 min ⁻¹	7000 mm/min (275.59)	1960 cc/min	U Drill	A5052	Ø30mm (1.18)	1800 min ⁻¹	700 mm/min (27.55)	495 cc/min
	S45C	Ø80mm (3.14) 5 blades	W=70mm (2.75) D=2mm (0.07)	1320 min ⁻¹	2600 mm/min (102.36)	364 cc/min		S45C	Ø27mm (1.06)	1500 min ⁻¹	320 mm/min (12.59)	183 cc/min
End mill	A5052	Ø25mm (0.98) 2 blades	W=22mm (0.86) D=6mm (0.23)	20000 min ⁻¹	11000 mm/min (433.07)	1452 cc/min	Tap	A5052	M36 ×P4.0	120 min ⁻¹	480 mm/min (18.89)	—
	S45C	Ø20mm (0.78) 4 blades	W=3mm (0.11) D=30mm (1.18)	5000 min ⁻¹	5000 mm/min (196.85)	450 cc/min		S45C	M24 ×P3.0	100 min ⁻¹	300 mm/min (11.81)	—

MX-520

[Specification / Equipment]

Standard Machine Specifications

Movement and Ranges		
X-axis stroke	[mm (in.)]	630 (24.80)
Y-axis stroke	[mm (in.)]	560 (22.04)
Z-axis stroke	[mm (in.)]	510 (20.07)
A-axis rotation angle	[deg]	-125 ~ +10
C-axis rotation angle	[deg]	360
Table		
Working surface	[mm]	φ 300
Loading capacity	[kg (lb.)]	200 (440)
Max. workpiece size	[mm (in.)]	φ 520 × H350 (φ 20.47 × H13.77) φ 710 × H350 (φ 27.95 × H13.77) (with restrictions)
Spindle		
Spindle speed	[min ⁻¹]	40 - 12000 (auto grease lubrication)
Spindle speed change command		S5 digits direct command
Type of spindle taper hole		7/24 taper #40 (BT double contact type)
Spindle bearing inner diameter	[mm (in.)]	φ 80 (φ 3.14)
Max. spindle torque	[N·m]	120/880min ⁻¹
Feedrate		
Rapid traverse rate X / Y / Z	[mm/min (ipm)]	4000/4000/4000 (1574.8)
A / C	[min ⁻¹]	17 / 33
Feedrate X / Y / Z	[mm/min (ipm)]	1 - 40000 / 1 - 40000 / 1 - 40000 (0.03 - 1574.8)
A / C	[min ⁻¹]	17 / 33
Automatic Tool Changer		
Type of tool shank		JIS B 6339 tool shank 40T
Pullstud		JIS B 6339 pullstud 40P
Tool storage capacity	[tools]	60 (Chain magazine)
Max. tool diameter (With adjacent tools)	[mm (in.)]	φ 80 (φ 3.14)
(Without adjacent tools)		φ 150 (φ 5.90)
Max. tool length	[mm (in.)]	300 (11.81)

Max. tool mass	[kg (lb.)]	10 (22.05)
Method of tool selection		Memory random system
Power Sources		
Electrical power supply	[kVA]	44 (Depends on the options provided)
Power supply voltage	[kVA]	AC 200/220±10% (50/60Hz)
Power supply frequency	[Hz]	50/60±1
Transformer required for the voltage except above		
Tank Capacity		
Hydraulic oil tank capacity	[L]	10
Coolant tank capacity	[L]	560
Oil cooler tank capacity	[L]	14 (Total capacity:16)
	[L]	7 (Total capacity: 9) (20000min ⁻¹ options)
Machine Size		
Machine weight	[kg (lb.)]	9450 (20833)
NC System		
Control system		Matsura G-Tech31
Standard Accessories		
Total splash guard		ATC magazine guard
ATC auto door		Spindle oil cooler
Auto grease supply unit for feed axes		Scale feedback (A/C axis)
Coolant unit		Chip flush
Chip flow		Work light
Synchronized tapping function		AD-TAP function
IPC function		Spindle overload protection function
M-code counter (9 kinds)		Spindle thermal displacement compensation system
Software tool for memory card program operation & editing		MIMS (Matsura Intelligent Meister System)
Intelligent Protection System		Integrating spindle run hour meter
Integrating auto run hour meter		Service tools and tool box
Machine color paint		Leveling bolts, leveling plates

* 2 years spindle warranty

List of Fittings

Spindle		
12000min ⁻¹ (BT40 auto grease lubrication)		○
12000min ⁻¹ (BT40 auto grease lubrication)		▲
Spindle motor output	kW	15 / 22
Max. spindle torque	N·m	187.3
20,000min ⁻¹ (BT40 auto grease lubrication)		▲
Spindle motor output	kW	Low: 11 / 15, High: 15 / 18.5
Max. spindle torque	N·m	108.4
Tool Storage Capacity		
60 tool (Chain magazine)		○
90 tool (Chain magazine)		▲
120 tool (Chain magazine)		▲
Table		
φ 300mm		○
φ 500mm		▲
φ 300mm + Flat Table		▲
Number of Pallets		
1 (Single pallet) *1		▲
4 (Floor pallet system) *2		▲
Automation Package		
Automation package (PC4, 90tools, Spiral)		▲
High Accuracy Control		
Scale feedback X-/Y-/Z-axis		▲
X/Y/Z thermal displacement compensation		▲
Environmental thermal displacement compensation (12000min ⁻¹ spindle)		▲
Environmental thermal displacement compensation (20000min ⁻¹ spindle)		▲
Coolant		
Vacuum type coolant through A 7MPa		▲
Vacuum type coolant through A 14MPa		▲
Vacuum type coolant through B 7MPa		▲
Vacuum type coolant through B 14MPa		▲
Vacuum type coolant through C 2MPa		▲
Vacuum type coolant through C 7MPa		▲
Mist separator (without fire damper)		▲
Mist separator retrofitting (MC guard side)		▲
Coolant temperature controller with tank 100L		▲

Automatic Measurement, Tool Breakage Detection		
I.p.measure/auto.centring(optic,renishaw,matsura macro)		▲
I.p.measure/auto.centring(optic,renishaw,renishaw macro)		▲
I.p.measure/auto.centring(renishaw macro only)		▲
In-process measure/auto.centring(optic)blum)		▲
Broken tool detection/laser system,renishaw		▲
External tool breakage (60 / 90tools, contact)		▲
Chip Removal		
Chip bucket		▲
Spiral conveyor		▲
Lift-up conveyor (scraper)		▲
Air blow for chip removal		▲
Workpiece cleaning gun (machine side)		▲
Operation/Maintenance Support		
Reliability Meister Plus Type A (with PC)		▲
Reliability Meister Plus Type B (without PC)		▲
Additional eight M functions		▲
Spindle load monitoring function		▲
Weekly timer		▲
3-color signal light (red, yellow, green from top)		▲
100 VAC Socket (3A)		▲
Optional block skip addition 2 to 9		▲
External manual pulse generator		▲
eZ-5 (with calibration sphere)		▲
eZ-5 (without calibration sphere)		▲
Pressure supply system for fixtures (6-port, 19.6MPa)		▲
Rotary wiper (Air)		▲
Rotary wiper (Electric)		▲
OP auto door		▲
Robot interface + auto door		▲
Robot + auto door		▲
Optional Package		
High-speed, high-precision package		▲
5-axis package		▲
High-speed, high-precision 5-axis package		▲

*1 Max. workpiece size : φ 710 x H330(mm) (with restrictions), 175kg

*2 Max. workpiece size : φ 520 x H330(mm), 175kg

*3 Depending on the tool diameter, maximum workshape is limited

Ø300mm Table top view

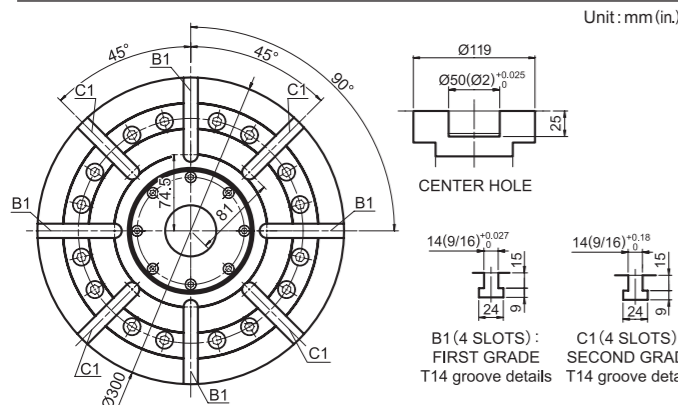

Ø500mm Table top view

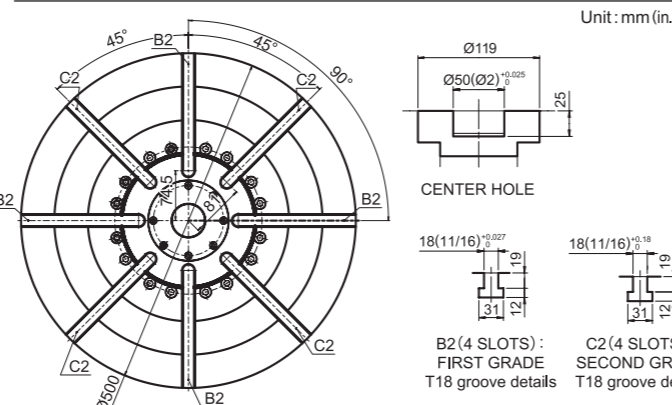

MX-520 Floor plan

Unit: mm (in.)

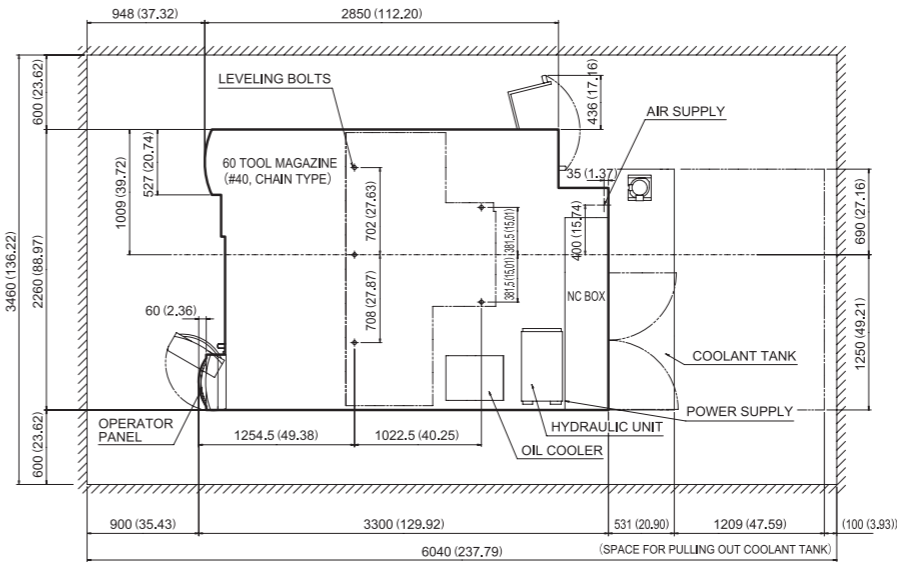

MX-520 External view

Unit: mm (in.)

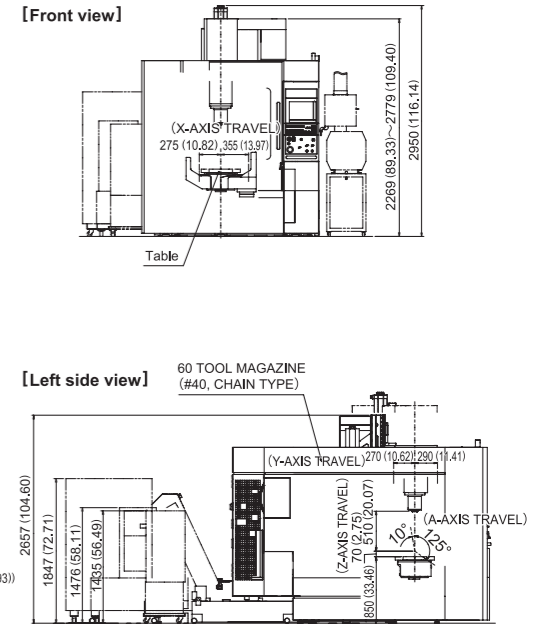

MX-520 PC4 Floor plan

Unit: mm (in.)

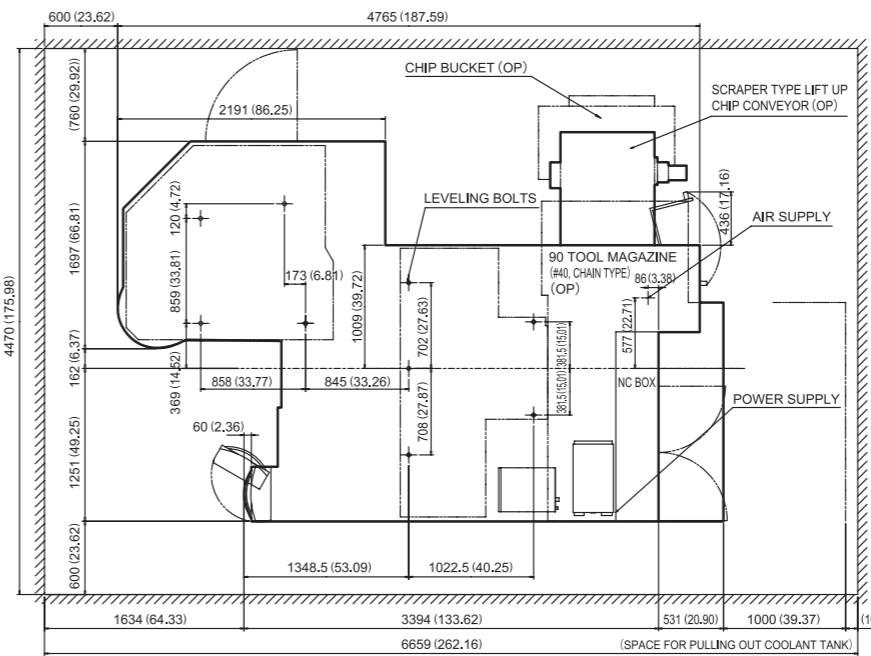

MX-520 PC4 External view

Unit: mm (in.)

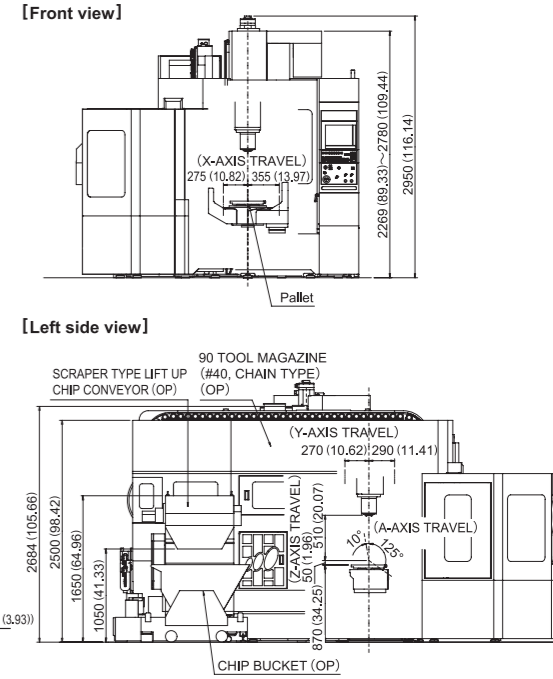

Ø300mm + Flat Table top view

